

INVESTIGATION OF SHEET METAL FORMING BY BENDING— PART IV: BENDING AND WRINKLING OF CIRCULAR SHEETS PRESSED BY A HEMISPHERICAL PUNCH

L. C. ZHANG,* T. X. YU† and R. WANG†

*Department of Mechanics, Zhejiang University, Hangzhou, China and †Department of Mechanics, Peking University, Beijing, China

(Received 24 June 1988; and in revised form 1 October 1988)

Abstract—This paper reports on an investigation of the bending forming processes in circular sheets pressed by a hemispherical punch into a conical die. Both theoretical and experimental considerations are provided. It is pointed out that the deformation mechanism of such a circular plate is different from that of the workpiece in the conical die cup test studied previously in part III of this series [*Int. J. Mech. Sci.* 31, 327-333 (1989)]. The theoretical analysis shows that a central gap appears between the plate and the hemispherical punch at small deflections and disappears when the punch force increases beyond a certain magnitude. It is then shown that the previous approximate analytical treatment of the distribution of punch force is no longer appropriate to the wrinkling of the plate. It is shown that, as in the case of the conical die cup test, the circumferential wave number for the wrinkling mode corresponding to the critical wrinkling load of the present workpiece is four. In addition, the paper reveals that a doubling of the wrinkling wave may occur in the first stage of the forming process.

NOTATION

See Ref. [1, part I].

1. INTRODUCTION

Stamping with hemispherical punches and dies to form shallow spherical shells is a common forming process in the production engineering of sheet metals (see Fig. 1). However, to design dies that result in a desired shell shape and to determine deformation limits where wrinkling begins, one should understand the deformation process of a workpiece, which in this case involves the changing pattern of contact between the punch, plate and die, as well as the change of wrinkling modes. Thorough discussions on the problem have been few. Johnson and Singh [2] pointed out that according to their experimental analysis the springback of the circular plate pressed by a hemispherical punch increased as the radius of the plate decreased. Their experiments also showed that a central gap appeared between the plate and the punch at small deflection and disappeared as the plate deflection increased beyond a certain point. Yu, Johnson and Stronge [3, 4] investigated the same problem experimentally and analytically. They gave the experimental relationship between punch travel and force and derived formulae for calculating springback and wrinkling load on the basis of the assumptions that the plate was either elastic or rigid-perfectly plastic and that the action of the punch was considered as a ring load even in the analysis of wrinkling. Their latter assumption was based on the fact that a central gap

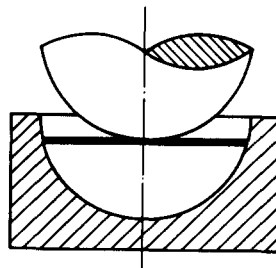

FIG. 1. Spherical forming of circular sheets.

between the plate and the punch existed. Their experimental results showed that the circumferential wave numbers in the wrinkling modes ranged from four to six, but their analytical formula led to two waves, which corresponded to critical wrinkling. Yasuhisa, Kawada and Tozawa [5] provided the distributions of the surface strains in soft and hard aluminium plates and gave the relationship between punch load and displacement. They also studied the forming load, using an approximate but simple analytical method. Their experiments showed that the wrinkling loads of thinner or harder plates were evidently lower than those of thicker or softer ones. In addition, they discussed the strain distribution, using the principle of minimum internal work [6].

The process of forming a circular plate stamped by a hemispherical punch and die can be divided into three stages. The first is one in which the plate contacts the die only on the plate periphery. Elastic-plastic bending is the main reason for deformation in this stage, but wrinkling may often occur too. The second is the stage when the plate is in contact with the punch and the whole die. The workpiece is ironed by the punch and die. The extent of identification of the workpiece with the die depends significantly on the shape and number of the wrinkling waves which appear in the first stage. Generally, the smaller the amplitude (the greater the number of the waves), the better the workpiece coincides with the die. The third is the stage of springback as the punch is removed. The deformation history during forming in stages one and two affects greatly the amount of springback. In fact, analytical studies carried out in the papers mentioned above [2–6] were limited to the deformation of the first stage, because the most representative phenomena of the mechanics of such a forming process as stated above appear in this stage. It is therefore necessary to understand fully the deformation mechanism.

The present paper investigates the first stage of deformation of workpieces experimentally and theoretically. As a workpiece in this stage is in contact with the die only on its periphery, in this study the hemispherical die was replaced with a conical one so that the rigid displacement of the workpiece could be measured very conveniently. This replacement does not lose any important characteristic of the original problem. The new system is shown in Fig. 2. The paper reveals some new features of the problem which have not been found by previous researchers, and points out that the deformation process of the present workpiece is very different from that in the conical die cup test. The theoretical approach proposed in [6] by the authors is used again.

2. DESCRIPTION OF EXPERIMENTS AND EXPERIMENTAL RESULTS

The experimental arrangement of tools which carries out the technological process of Fig. 2 is shown in Fig. 3. Workpieces were made of cold-rolled steel plates, which were originally flat and showed no working marks on the surfaces. The semi-angle of the conical die was 20° . The punch, workpiece and die were set concentrically, and the workpiece initially rested horizontally in the die with the periphery in continuous contact. No lubrication was used in the tests. The hemispherical punch was pressed into the workpiece at a slow rate of 3 mm min^{-1} . The appearance of the wrinkling wave was detected by two linear transducers set at different radii, which could rotate around the common axis of the punch, die and workpiece (cf. Fig. 3). The curves relating the punch displacement and force were drawn by the DSS-25^T testing machine. Surface strains were measured by strain

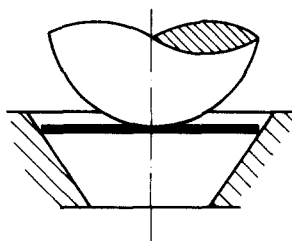

FIG. 2. The present forming process.

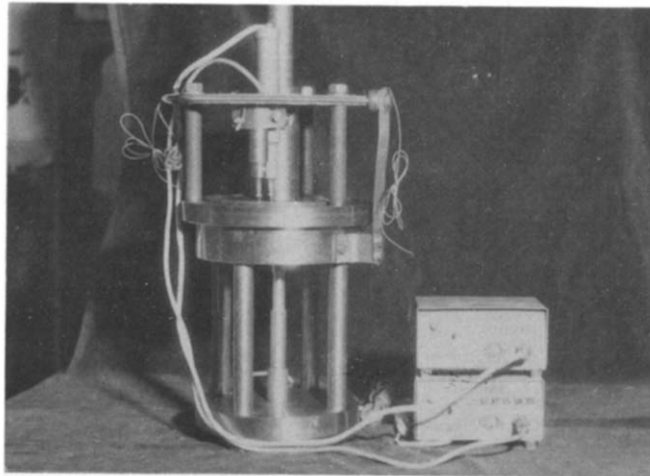

FIG. 3. The arrangement of the experimental tools.

gauges of type BX-120-1AA. Notation similar to that in Ref. [1] is used for the specimens. For example, 150-2.0-S200 stands for a circular plate of diameter 150 mm and thickness 2.0 mm subjected to a ring load caused by the hemispherical punch with diameter 200 mm, where the letter 'S' means 'spherical'.

The punch force–punch displacement curves are similar to those provided by the earlier papers [2–6]. They do not show any new features. Only a portion of them will be given below, for the purposes of comparing them with theoretical results.

2.1. Variations of curvature

Figures 4 and 5 show the residual radial curvatures of workpieces 120-2.0-S200, 120-1.5-S200 and 150-2.0-S200 after unloading at different levels. Comparison of these results with those of conical die cup specimens provided by the authors previously (see Fig. 8 of paper [1]) shows that the variations of the radial curvature of the former are more complicated than those of the latter. The main factor is that the contact circle (or area) between the plate and the punch in the present problem varies with external load. It is evident from Figs 4 and 5 that at small deflections, there exists a lower curvature region near the plate centre, but it is flattened as the external load increases. The appearance of a higher curvature region inside the periphery is the same as in the conical die cup test, and their mechanisms are therefore similar. The distribution of radial curvatures of 150-2.0-S200, measured after wrinkling, shows that the radial peaks of the wrinkling mode appear inside the periphery, which is also in accordance with the conclusion from the conical die cup test [1]. This is very unfavourable to the second deformation stage, because to iron such a wrinkling wave, a powerful press would be needed, and the service lives of dies are then shortened; moreover, the workpiece may fracture at the periphery.

2.2. Observation of the deformation process from press marks

The press marks* shown in Fig. 6 reveal the variations of the contact areas between hemispherical punches and dies. They show that the deformations of the plates are

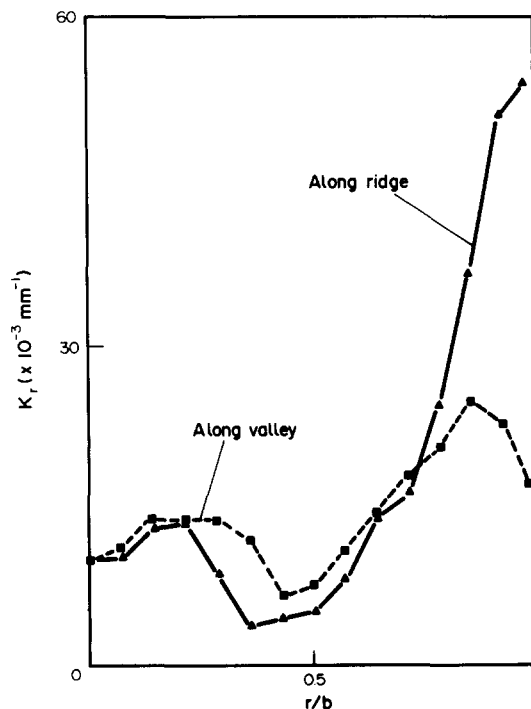

FIG. 4. Residual radial curvatures of 150-2.0-S200.

* Before pressing, a carbon sheet was put between the punch and the specimen, so that it made marks on the specimen during pressing.

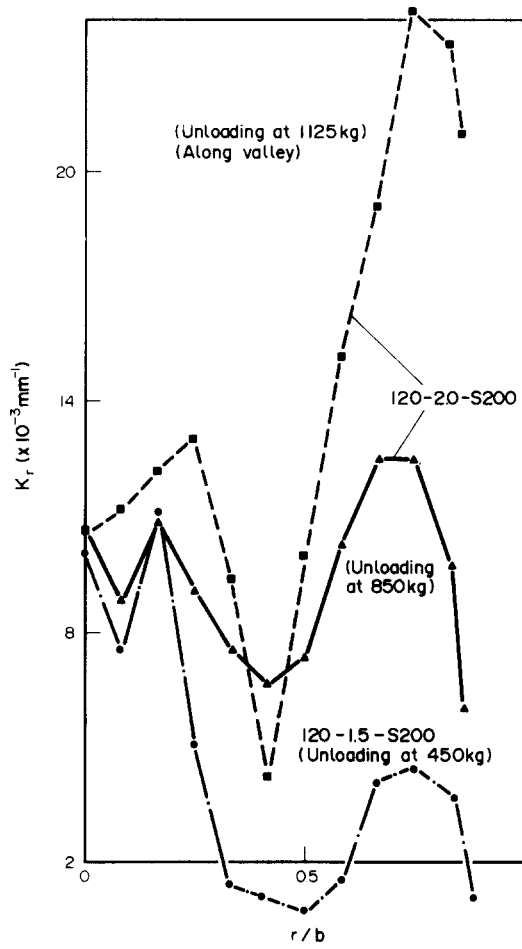

FIG. 5. Residual radial curvatures of 120-2.0-S200 and 120-1.5-S200.

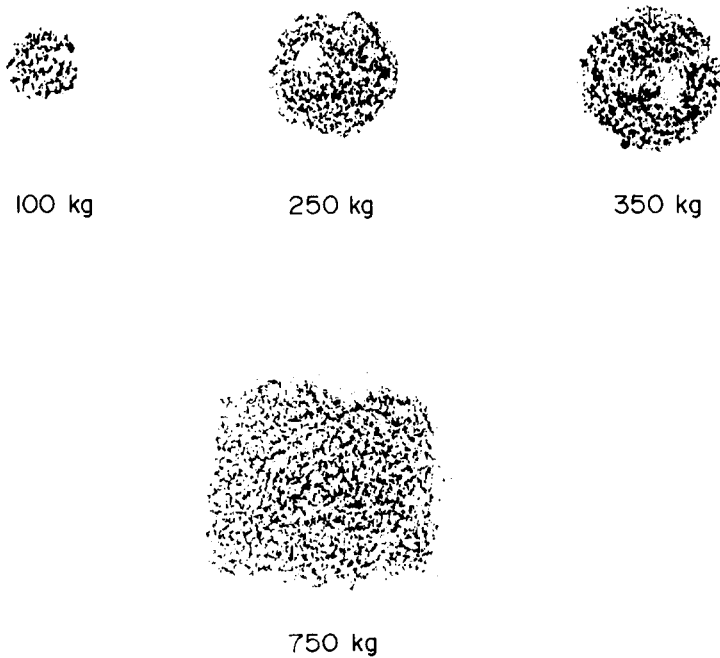

FIG. 6 (a).

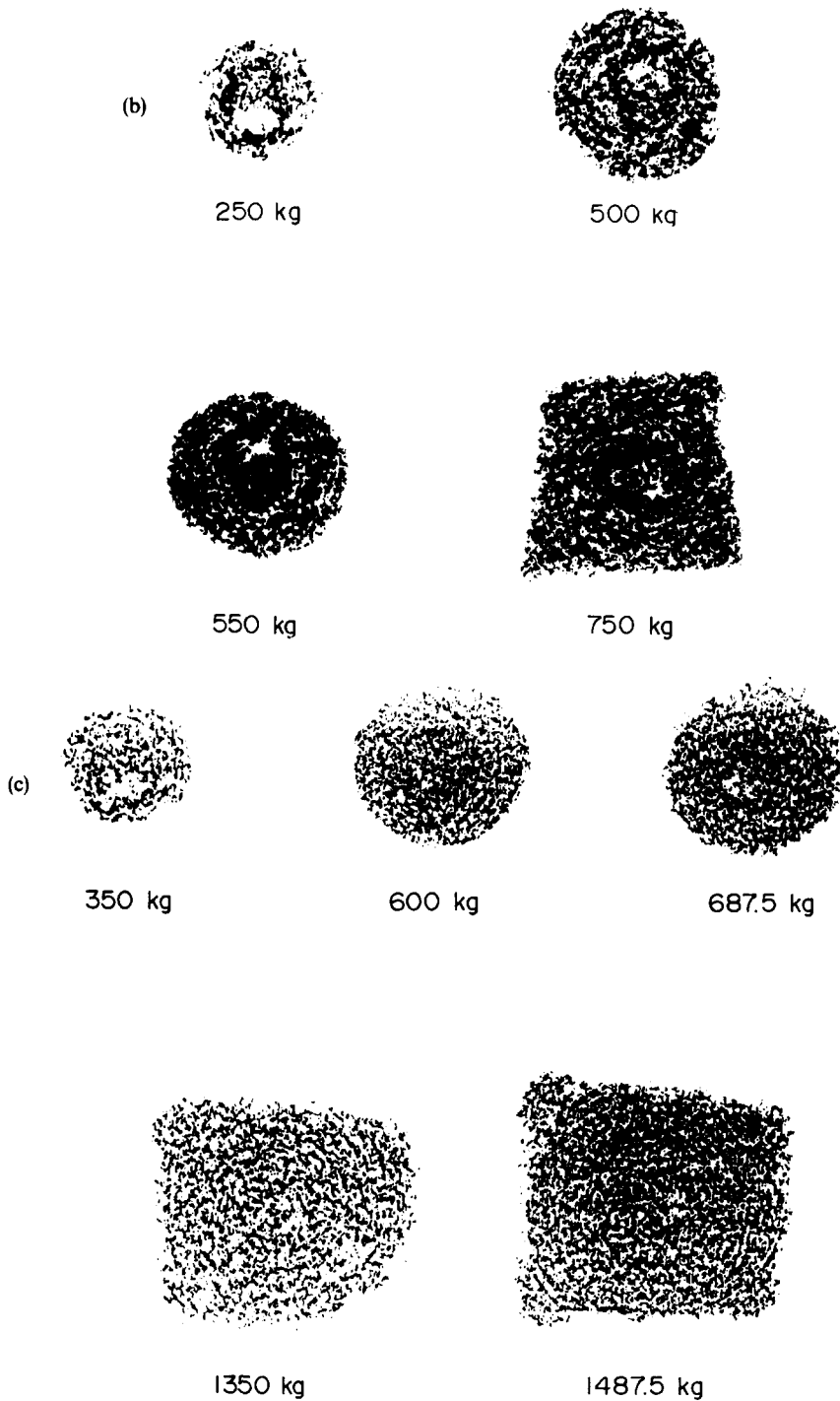

FIG. 6. Press marks between punch and plate: (a) 120-1.5-S200; (b) 150-1.5-S200; (c) 150-2.0-S200.

axisymmetric before wrinkling (corresponding to the circular press marks) and then become non-axisymmetric as wrinkling waves appear, which make the circular press marks change to polygons, owing to the contacts between the punch and the wave ridges. Figure 7 shows the variations of press mark diameters with external loads.

2.3. Circumferential shape of the wrinkling wave and doubling

Figure 8 shows photographs of 150-1.5-S200 after wrinkling. The four waves distributed circumferentially are visible, and their circumferential forms are as indicated in Fig. 9. The photographs exhibit more directly the fact that the radial peaks of the waves do not lie at

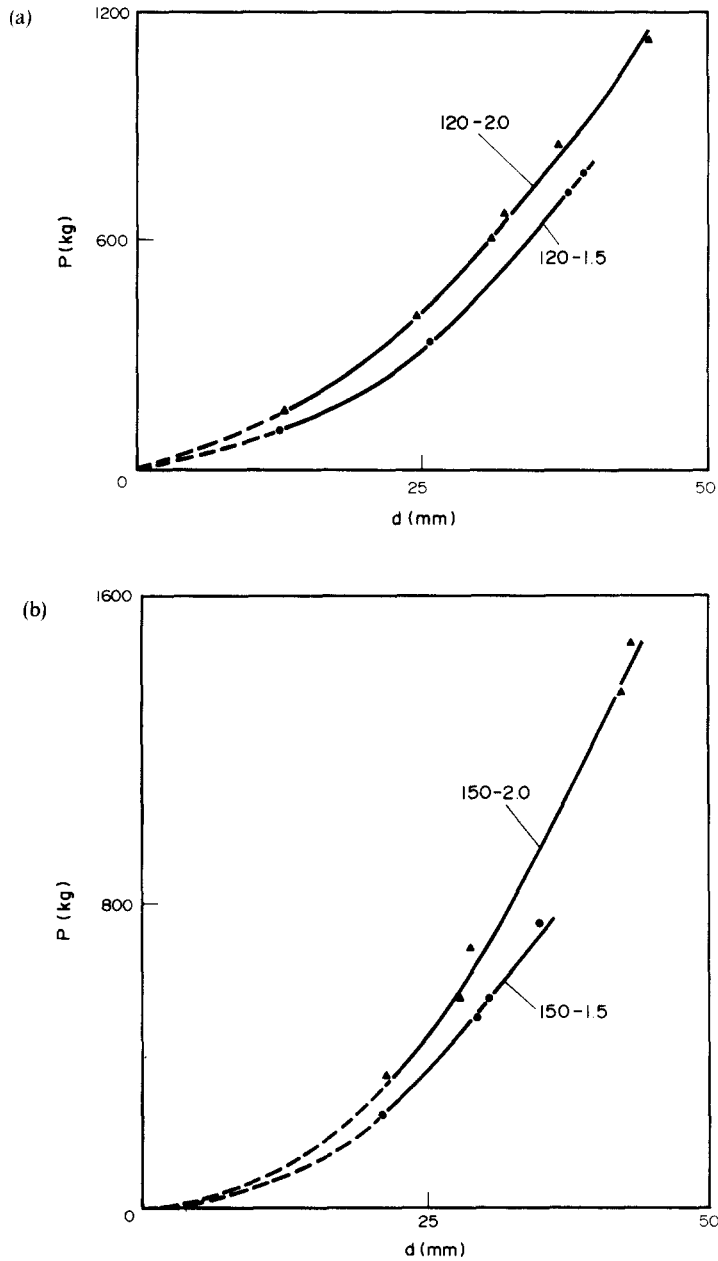

FIG. 7. Variations of press mark diameters with external loads: (a) 120-1.5-S200 and 120-2.0-S200; (b) 150-1.5-S200 and 150-2.0-S200.

the periphery of the plate but inside it. Tests for each kind of specimens 150-1.5-S200, 150-2.0-S200, 120-1.5-S200 and 120-2.0-S200 repeated from 3 to 5 times under the same conditions led to wrinkling modes identical to those shown in Fig. 8. Moreover, curves of punch load versus displacement from repeated tests were in good agreement with each other. Moreover, it is obvious from these results that the four-wave wrinkling mode corresponds to the critical wrinkling load, and that the wrinkling is insensitive to small initial imperfections. This is the same as the conclusion from conical die cup tests. Therefore, this is a general feature of problems of this kind.

A special example which led to a three-wave wrinkling mode and then doubled to a six-wave mode was found in the repeated tests on 120-1.5-S200 (see Figs 9 and 10), where the three-wave mode corresponded to a wrinkling load of $P^* = 612.5$ kg. However, four-

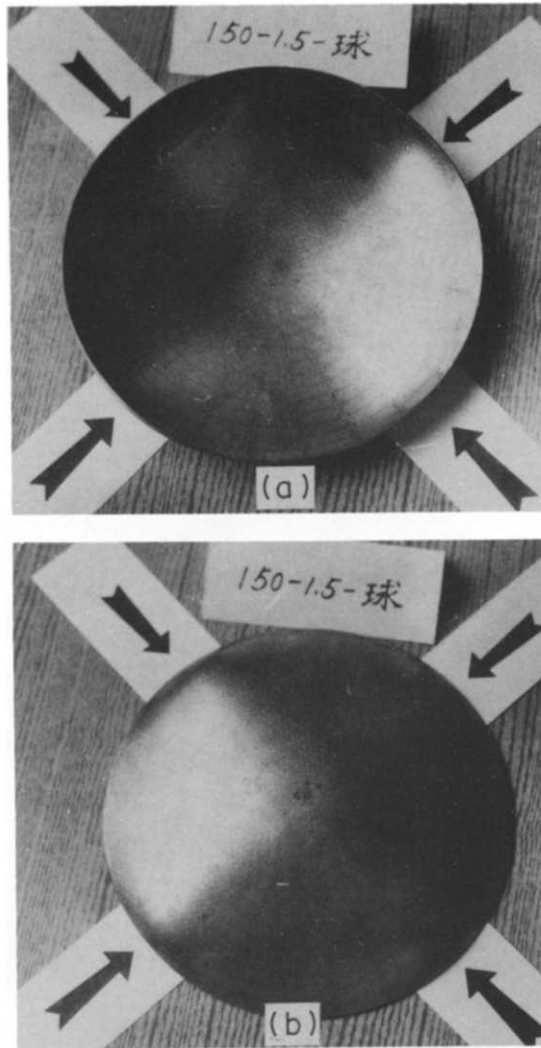

FIG. 8. Wrinkling mode of 150-1.5-S200: (a) loading surface; (b) back surface.

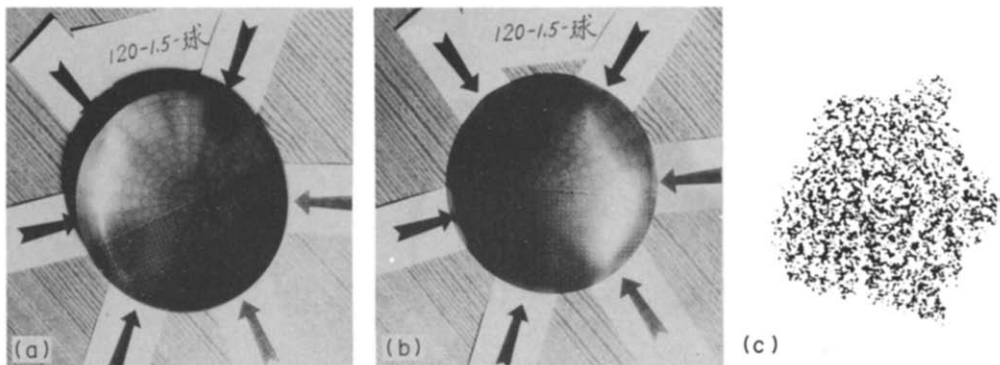

FIG. 10. Wrinkling mode of 120-1.5-S200: (a) loading surface; (b) back surface; (c) press mark.

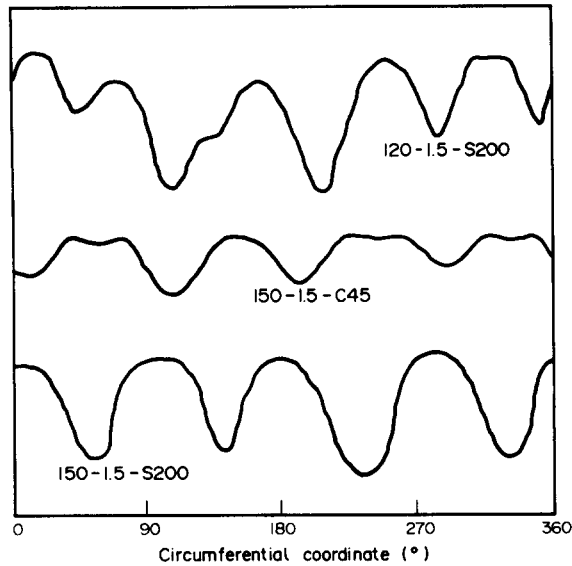

FIG. 9. Circumferential shapes of wrinkling modes.

wave modes for the same specimens corresponded to $P^* = 562.5$ kg. Furthermore, the central displacement of the former at wrinkling is 14.17 mm, but in the latter it is 12.20 mm. The appearance of this special example further supports the conclusion that the four-wave mode corresponds to the critical load.

The doubling of the wrinkling waves was first pointed out by Senior, and was described in some detail by Johnson and Mellor [7] and Yu, Johnson and Stronge [3]. However, they all thought that this phenomenon was similar to that in a deep-drawing process when a blank-holder is used, so that the wave doubling of the workpiece pressed by a hemispherical punch was due to the contacts between the punch and the wave ridges. However, the present experiments show that this is not the case, because in some of the tests the doubling occurred before the wrinkling waves made contact with the punch. The doubling phenomenon of the waves of 150-1.5-C45 shown in Fig. 9 is such an example, where the specimen was pressed by a cylindrical punch so that no contact could occur with the wave ridges. The mechanics of this phenomenon should be studied further.

3. THEORETICAL RESULTS AND COMPARISON WITH EXPERIMENT

Very large computer time is required to carry out a rigorous theoretical calculation because the present problem is one of contact and the contact areas between the punch and the plate are not known in advance. Fortunately, the present paper aims to discuss the qualitative difference between the deformation process for the present problem and that in the conical die cup test to provide basic information for technological design and further for theoretical research. Thus, the simplified loading condition shown in Fig. 11 can be applied according to the following measures and assumptions to save computer time:

- (i) the action of the hemispherical punch is equivalent to a ring load at the periphery of the contact area between the punch and the plate (it has been so used by Yu *et al.* [3]).
- (ii) the radius of the ring load, r_p , is determined by the present experimental results (Fig. 7).

In so doing, the authors obtained numerical results very conveniently with the aid of the maDR method, which has been applied successfully in our previous researches [1]. The governing equations, material properties of the plate, the friction coefficient, etc. are the same as in [1].

Figure 12 shows some of the present theoretical results and the comparisons with experimental ones. It successfully exhibits the difference between the deformation process in

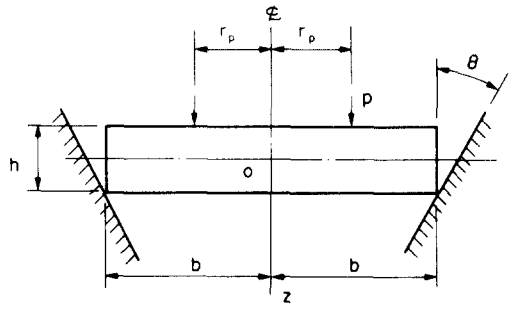

FIG. 11. The simplified model for theoretical analysis.

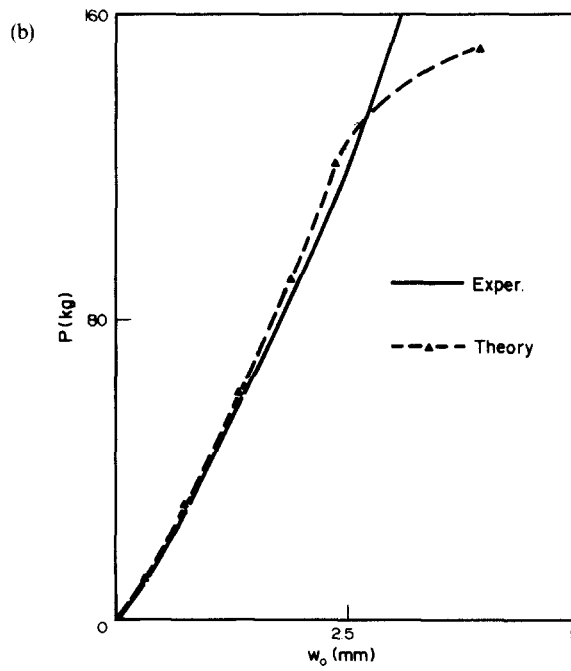
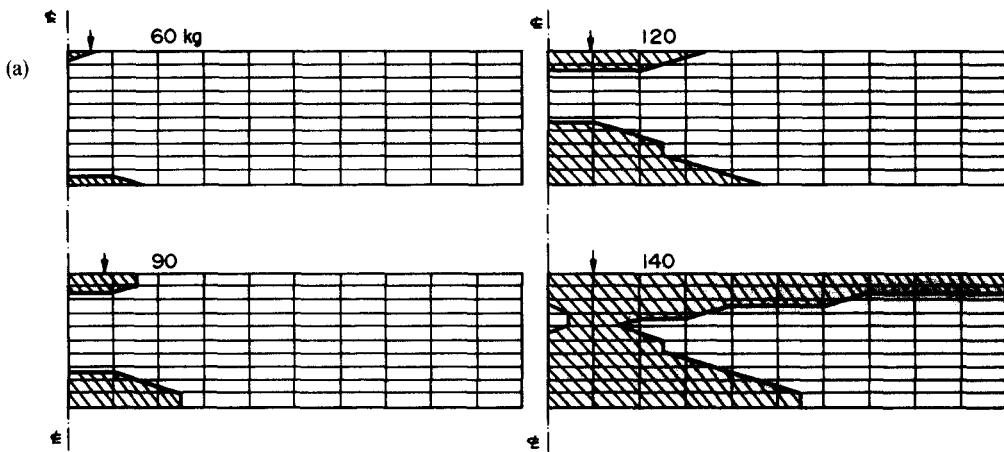

FIG. 12 (a) and (b).

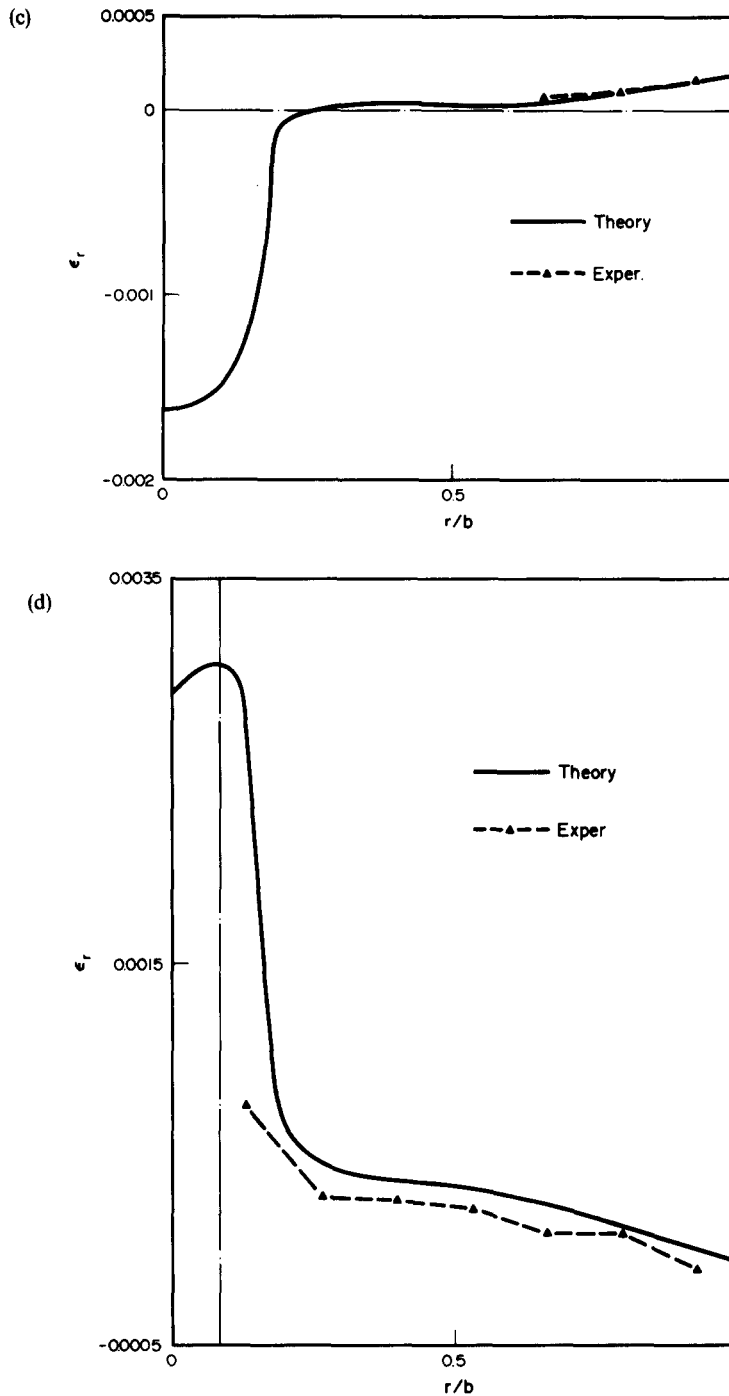

FIG. 12. Comparisons of theoretical results of 150-2.0-S200 with experiment: (a) developments of plastic regions; (b) punch load-punch displacement curves; (c) radial strain on $z = -h/2$ when $P = 120$ kg; (d) radial strain on $z = h/2$ when $P = 120$ kg.

the present problem and that in the conical die cup test and reveals the great limitation of the approximate treatment for the action of the punch adopted in [3]. Figure 12(a) shows that the upper and lower plastic regions of the plate appear first near the central axis and then spread to the periphery with the increase of the ring load radius. As has been revealed in the authors' previous papers [1], the development processes for the plastic regions in the plates in the conical die cup tests were different from the former. Obviously, their different deformation processes yield very different third stages of forming, i.e. springback.

It is found from Fig. 12(b)–(d) that the approximate treatment of the punch load leads to very good results in respect of both the load–displacement relation and the strain distributions when the external load is less than 130 kg. However, as the external load increases further, the theoretical results far exceed the experimental ones (cf. Fig. 12(b), and also Fig. 12(a), which shows that the spread of the plastic region is extraordinarily fast when the external load increases from 120 kg to 140 kg). It shows that the approximate treatment is no longer appropriate when the external load extends beyond a value which is far less than the wrinkling load (for the 150-2.0-S200 analysed above, the wrinkling load is 1105 kg). It follows that at small deflections, there indeed exists a central gap between the punch and the plate and hence in this stage the approximate treatment is admissible. However, as the punch load increases, the small gap disappears, leading to a redistribution of the punch load in the plate; adopting the approximate treatment is equivalent to adding an extra load to the plate because it distributes the total punch load to the boundary of the contact area and forces the curvature of the plate element inside the boundary to that of the punch at the same time. The results from this approach must therefore far exceed realistic values. It then follows that this method is inadmissible in studying wrinkling. This is the reason for Ref. [3] providing an unrealistic wrinkling mode.

4. CONCLUSIONS

- (1) A four-wave mode corresponds to the critical wrinkling load.
- (2) The doubling of the wrinkling waves may appear in the first stage of deformation; further investigation of its mechanism is recommended.
- (3) The approximate treatment of punch load is admissible only at the small deflection stage.
- (4) The fact that the radial peaks of the wrinkling waves appear inside the periphery of the plate will greatly affect the ironing process in the second deformation stage; designers should consider this factor in advance in the design of dies.

Acknowledgements—The authors would like to acknowledge the support of the Chinese National Natural Science Foundation for this research. They also wish to express their thanks to Professor W. Johnson for helpful comments on an earlier draft of this work.

REFERENCES

1. L. C. ZHANG, T. X. YU and R. WANG, Investigation of sheet metal forming by bending. Part I: axisymmetric elastic–plastic bending of circular sheets pressed by cylindrical punches; part II: plastic wrinkling of circular sheets pressed by cylindrical punches; part III: applicability of deformation theory to stamping of circular sheets. *Int. J. Mech. Sci.* **31**, 285–300, 301–308, 327–333 (1989).
2. W. JOHNSON and A. N. SINGH, Springback in circular blanks. *Metallurgia*, May, 275–280 (1980).
3. T. X. YU, W. JOHNSON and W. J. STRONGE, Stamping and springback of circular plates deformed in hemispherical dies. *Int. J. Mech. Sci.* **26**, 131–148 (1984).
4. W. J. STRONGE, M. P. F. SUTCLIFFE and T. X. YU, Wrinkling of elasto-plastic circular plates during stamping. *Exp. Mech.* 345–353 (1986).
5. HIDEO YASUHISA, HATSUMI KAWADA and YASUHISA TOZAWA, Forming force in spherical forming of circular plates. *J. Jap. Soc. Technology Plasticity* **22**, 1223–1229 (1981).
6. HIDEO YASUHISA, HATSUMI KAWADA and YASUHISA TOZAWA, Strain distribution in spherical forming of circular plates. *J. Jap. Soc. Technology Plasticity* **27**, 846–851 (1986).
7. W. JOHNSON and P. B. MELLOR, *Engineering Plasticity*, pp. 313–314. Van Nostrand Reinhold, London (1973).